

Tip SKC

-Distantier special

Otel Inox

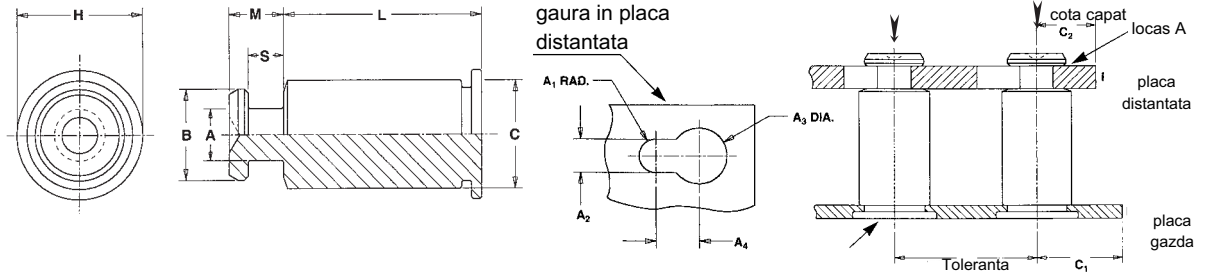

Tip	Cod	Cod lungime L ± 0,13										A	B	C	S	M	H	D
otel inox		6	8	10	12	14	16	18	20 ^{NS}	22 ^{NS}	25 ^{NS}	± 0.08	± 0.08	Max.	± 0.08	Max.	Nom	∅y
SKC	61.5	6	8	10	12	14	16	18	20 ^{NS}	22 ^{NS}	25 ^{NS}	2.5	4.5	5.38	1.72	2.75	6.35	5.5

Tip	PANEL 1					PANEL 2				Material	Grosime	C2 min.
	B ∅	Max. duritate	min. grosime	C1 min	toleranta	locas A						
						A1 Nom.	A2 ± 0.08	A3 ± 0.08	A4 Min.			
SKC	5.4	HRB 70	1	6.6	± 0.13	1.5	3	5	3.75	PC Board or Metal	1.45-1.62	4.1

MONTAJ SKC

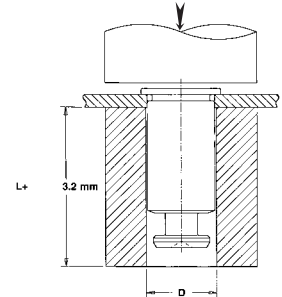

Tip SLPS

Pentru conectori

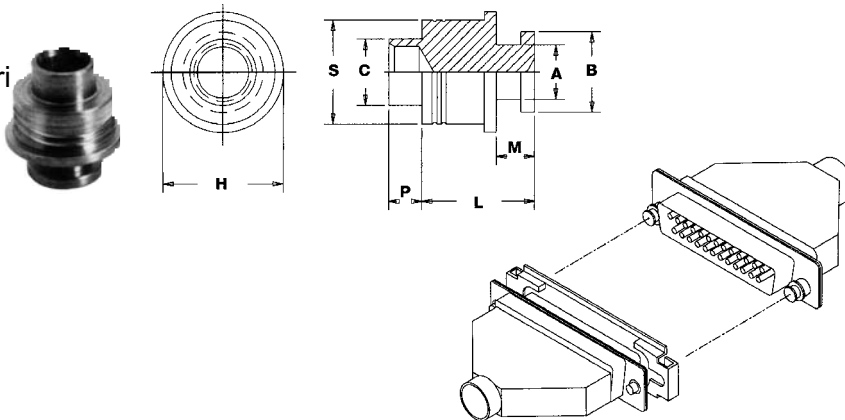

MONTAJ

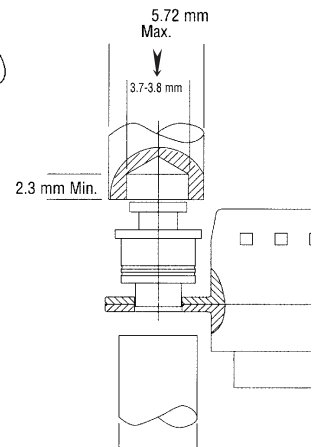

Tip	Cod margine	Grosime tabla	∅ gaura in conector	A ±.003	B ±.003	C Max.	H Non.	L ±.005	M Max.	P Max.	S ±.003	Cota minima capat
SLPS	120-172	.036 - .043	.120	.096	.143	.119	.218	.172	.073	.060	.188	.110

Elemente de panou cu sistem captiv

Tip PFK

pentru placi compozite sau cu duritate sub HRB 70

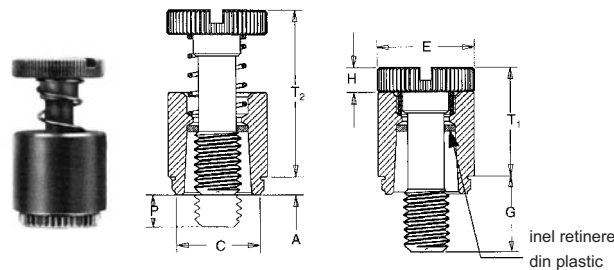

MONTAJ

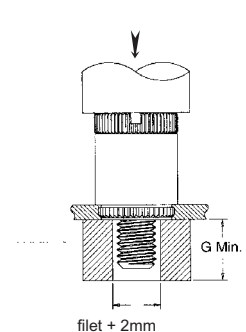

Filet	Tip	Cod filet	Cod lungime surub	A Max.	Grosime material	∅ in placa + 0.08	C ± 0.08	E + 0.4 - 0.13	G ± 0.4	H ± 0.13	P ± 0.13	T1 Max.	T2 ± 1.02	Cota minima capat
M3 x 0.5	PFK	M3	40	1.5	1.5	6.75	7.28	8.2	6.4	1.83	0	9.1	13.8	5.1
			62 ^{NS}											
			84 ^{NS}											

Tip PFC2 PFS2

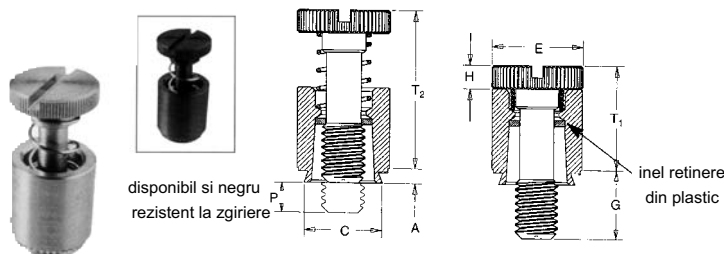

Filet	Tip		Cod filet	Cod lungime	A Max.	Grosime minima tabla	Øy in tabla + 0.08	C Max.	E +0.4 -0.25	G ± 0.4	H ± 0.13	P ± 0.4	T ₁ Max.	T ₂ ± 1.02	Cota minima capat
	ocel	otel inox													
M3 x 0.5	PFS2	PFC2	M3	40	1.5	1.5	6.75	6.7	7.9	6.4	1.83	0	9.1	13.8	6.4
				62 ⁹⁵						9.5		3.2			
M4 x 0.7	PFS2	PFC2	M4	50	1.5	1.5	7.95	7.9	9.5	7.9	2.08	0	11.4	17.7	7.9
				72 ⁹⁵						11.1		3.2			
				94 ⁹⁵						14.3		6.4			
M5 x 0.8	PFS2	PFC2	M5	50	1.5	1.5	8.75	8.7	10.3	7.9	2.08	0	11.4	17.7	8.7
				72						11.1		3.2			
				94 ⁹⁵						14.3		6.4			
M6 x 1	PFS2	PFC2	M6	60	1.5	1.5	10.5	10.5	11.9	9.5	2.49	0	14.6	22.4	9.5
				82 ⁹⁵						12.7		3.2			
				04 ⁹⁵						15.9		6.4			

Tip PFC2P

Capul surubului retras/inecat dupa insurubare

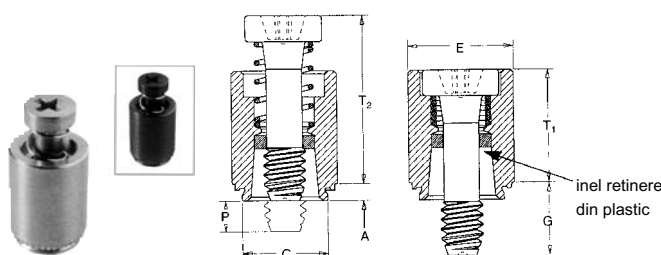

MONTAJ PFC2, PFS2, PFC2P

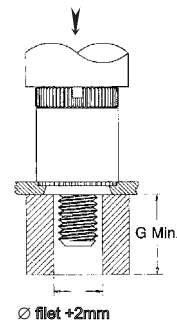

Filet	Tip	Cod surub	Cod filet	A Max.	Grosime minima tabla	gaura tabla + 0.08	C Max.	E ± 0.25	G ± 0.4	P ± 0.4	T ₁ Max.	T ₂ ± 1.02	Ghidaj nr.	Cota minima capat
M3 x 0.5	PFC2P	M3	40	1.5	1.5	6.75	6.7	7.9	6.4	0	9.4	13.8	#1	6.4
			62 ⁹⁵						9.5	3.2				
M4 x 0.7	PFC2P	M4	50	1.5	1.5	7.95	7.9	9.5	7.9	0	12.2	17.8	#2	7.9
			72 ⁹⁵						11.1	3.2				
			94 ⁹⁵						14.3	6.4				
M5 x 0.8	PFC2P	M5	50	1.5	1.5	8.75	8.7	10.3	7.9	0	12.4	17.8	#2	8.7
			72						11.1	3.2				
			94 ⁹⁵						14.3	6.4				
M6 x 1	PFC2P	M6	60	1.5	1.5	10.5	10.46	11.9	9.5	0	15.7	23	#3	9.5
			82 ⁹⁵						12.7	3.2				
			04 ⁹⁵						15.9	6.4				

Tip PF31 PF32

Pentru materiale cu o duritate pina la HRB60

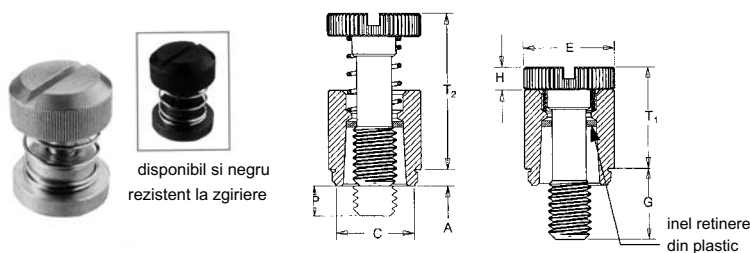

MONTAJ

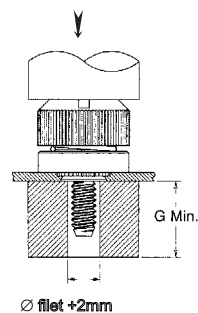

Filet	Tip	Cod filet	Cod lungime surub	A Max.	Grosime minima tabla	gaura in tabla + 0.08	C Max.	E +0.4 -0.13	G ± 0.4	H ± 0.13	T ₁ Max.	T ₂ ± 0.4	Cota minima capat
M3 x 0.5	PF31 ⁹⁵	M3	30	0.97	1	5.5	5.47	10.3	7.6	5.1	8.3	15.3	6.6
	PF32			1.47									
M4 x 0.7	PF31	M4	30	0.97	1	6.4	6.37	11.9	7.6	5.3	8.4	15.4	7.4
	PF32			1.47									
M5 x 0.8	PF31	M5	30	0.97	1	8	7.97	13.5	7.6	5.6	8.5	15.4	8.4
	PF32			1.47									
M6 x 1	PF32 ⁹⁵	M6	35	1.47	1.5	9.5	9.47	15.9	8.9	6.1	9.7	17	9.7

Tip PFHV

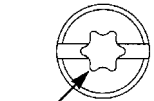

disponibil si cu locas cu 6 lobi

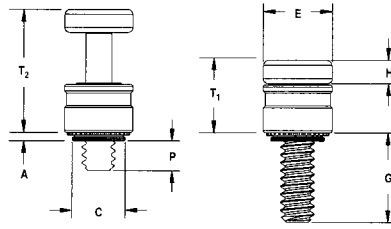

MONTAJ

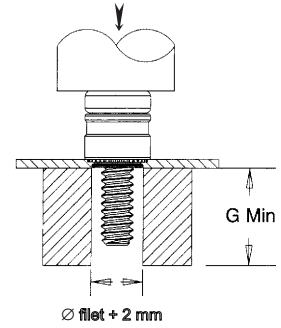

Filet	Tip	Cod filet	Cod lungime surub	A Max.	Grosime minima tabla	\varnothing_1 in tabla +0.08	C Max.	E ± 0.25	G ± 0.64	H ± 0.13	P ± 0.4	T ₁ Nom.	T ₂ Nom.	Ghidaj nr.	Cota minima capat
M3x0.5	PFHV	M3	0	0.86	0.92	5.5	5.47	6.95	5.55	2.03	0	6.69	11.25	#1	5.8
			1						7.56		1.9				
M3.5x0.6	PFHV	M3.5	0	0.86	0.92	6	5.97	7.45	6.01	2.34	0	7.45	12.47	#2	6.3
			1						8.42		2.3				
M4x0.7	PFHV	M4	0	0.86	0.92	6.4	6.37	7.85	6.59	2.79	0	8.5	14.1	#2	6.7
			1						9.39		2.7				

Tip PF11 PF12



Tip PF11



Tip PF12



disponibil si cu cap negru

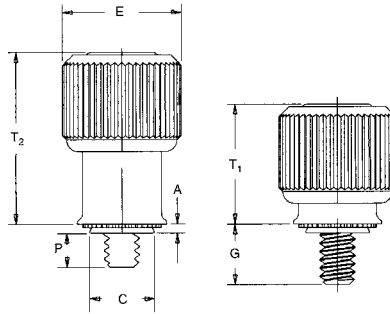

MONTAJ

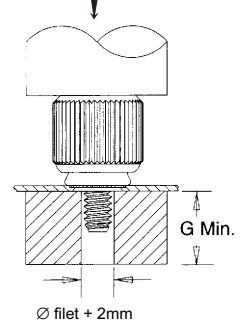

Filet	Tip		Cod filet	Cod lungime surub	A Max.	Gros. min. tabla	\varnothing_1 in tabla +0.08	C Max.	E ± 0.25	G ± 0.64	P ± 0.64	T ₁ Nom.	T ₂ Nom.	Ghidaj nr.	Cota minima capat
	PF11	PF12													
M3 x 0.5	PF11	PF12	M3	0	0.92	0.92	5.56	5.53	10.46	5.06	0	7.87	11.94	#1	7.1
				1						6.6	1.52				
				2						8.13	3.05				
M3.5 x 0.6	PF11	PF12	M3.5	0	0.92	0.92	6.35	6.32	11.25	5.84	0	11.18	16.26	#2	7.37
				1						7.37	1.52				
				2						8.89	3.05				
M4 x 0.7	PF11	PF12	M4	0	0.92	0.92	7.92	7.9	12.85	5.84	0	11.3	16.3	#2	8.4
				1						7.37	1.52				
				2						8.89	3.05				
M5 x 0.8	PF11	PF12	M5	0	0.92	0.92	7.92	7.9	12.85	5.84	0	11.3	16.3	#2	8.4
				1						7.37	1.52				
				2						8.89	3.05				
M6 x 1	PF11	PF12	M6	0	0.92	0.92	9.53	9.5	14.55	7.37	0	13.5	20.3	#3	11.7
				1						8.89	1.52				
				2						10.41	3.05				

Tip PFP standard cu cap din ABS negru (alte culori la cerere)

Filet	Tip	Cod filet	Cod lungime surub	A Max.	Grosime minima tabla	\varnothing_1 in tabla +0.08	C Max.	E ± 0.25	G ± 0.64	P ± 0.64	T ₁ Nom.	T ₂ Nom.	Ghidaj nr.	cota minima capat	Ecart lateral
M3 x 0.5	PFP	M3	0	0.92	0.92	5.16	5.13	13.77	5.84	0	11.07	16.15	#1	5.4	.38
			1						7.37	1.52					
M3.5 x 0.6	PFP	M3.5	0	0.92	0.92	5.56	5.53	13.77	5.84	0	11.07	16.15	#2	5.8	.51
			1						7.37	1.52					
M4 x 0.7	PFP	M4	0	0.92	0.92	6.35	6.32	15.09	5.84	0	11.07	16.15	#2	6.7	.51
			1						7.37	1.52					

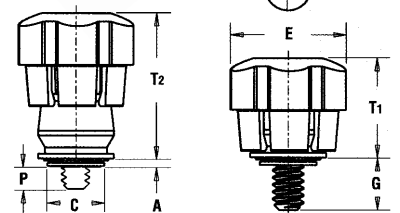
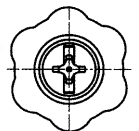

Tip PTL2

-Plunger cu arc
-pentru placi duritate max HRB 80.



disponibil si negru, rezistent la abraziune

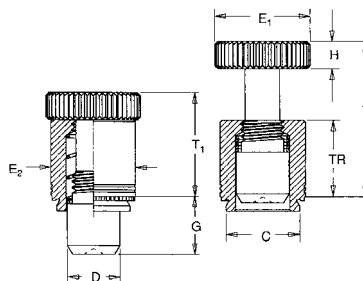

MONTAJ

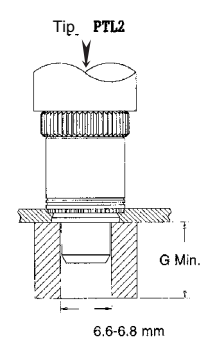

Filet	Cod \varnothing	Cod lungime	Grosime minima tabla	\varnothing_1 in tabla +0.08	C Max.	D ± 0.13	E ₁ +0.13 -0.25	E ₂ +0.13 -0.25	G ± 0.25	H ± 0.25	T ₁ ± 0.25	T ₂ ± 1.02	TR ± 0.13	Cota minima capat
PTL2	04	4	1.5	8.3	8.3	6.35	12.7	10.3	7.9	4.3	15.1	22.7	10.9	8.6

Tip PF10

Sistem retinere
cu surub inecat

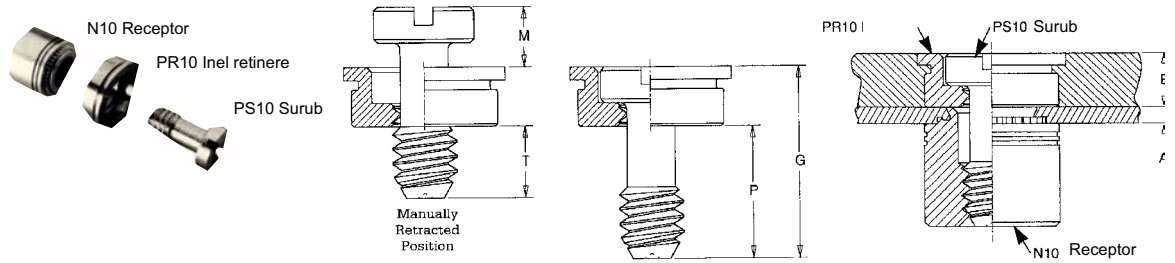

Tip PS10

Surub

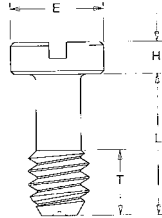

filet	Tip	Cod filet	Cod inel	E Nom.	H +0.05 -0.15	L ± 0.25	T Nom.
M3 x 0.5	PS10	M3	40	4.7	1.9	8.3	3.3
M4 x 0.7	PS10	M4	40	6.3	1.9	8.3	3.3
M5 x 0.8	PS10	M5	40	7.1	1.9	8.3	3.3

Tip PR10

Inel retinere

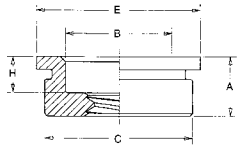

Filet	Tip	Cod filet	A Max.	Grosime min. tabla	Grosime la fata	∅ in tabla + 0.08	B Nom.	C Max.	E Nom.	H Nom.	Cota min. capat
M3 x 0.5	PR10	M3	3.15	1.4	3.2	7.1	5	7.08	7.9	2	7.9
M4 x 0.7	PR10	M4	3.15	1.4	3.2	8.75	6.5	8.71	9.5	2	8.7
M5 x 0.8	PR10	M5	3.15	1.4	3.2	9.5	7.4	9.47	10.3	2	9.2

Tip N10

Receptor

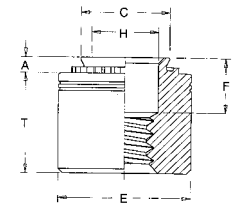

Filet	Tip	Cod filet	Cod inel	A Max.	Grosime min. tabla	∅ in tabla + 0.08	C Max.	E Nom.	F ± 0.25	H Nom.	T ± 0.13	Cota min. capat
M3 x 0.5	N10	M3	1	0.97	1	4.75	4.73	7.1	3.3	3.2	6	5.6
M4 x 0.7	N10	M4	1	0.97	1	6.4	6.38	8.7	3.3	4.7	6	7.1
M5 x 0.8	N10	M5	1	0.97	1	7	6.96	9.5	3.3	5.4	6	7.9

Tip F10

Piulita flotanta

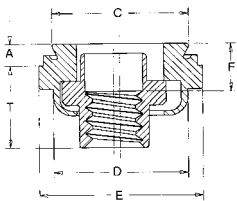

(sistem folosind piulita receptor F10 in loc de N10)

filet	Tip	Cod filet	Cod inel	A Max.	Grosime min. tabla	∅ in tabla + 0.08	C Max.	D Max.	E Max.	F ± 0.25	T ± 0.25	Cota min. capat
M3 x 0.5	F10 ^{MS}	M3	1	0.97	1	7.4	7.34	7.4	9.1	2.6	5.1	7.6
M4 x 0.7	F10 ^{MS}	M4	1	0.97	1	9.4	9.3	9.3	11.2	2.6	4.9	8.7
M5 x 0.8	F10 ^{MS}	M5	1	0.97	1	10.3	10.27	10.27	11.2	2.6	4.9	9

MONTAJ

PR10

F10

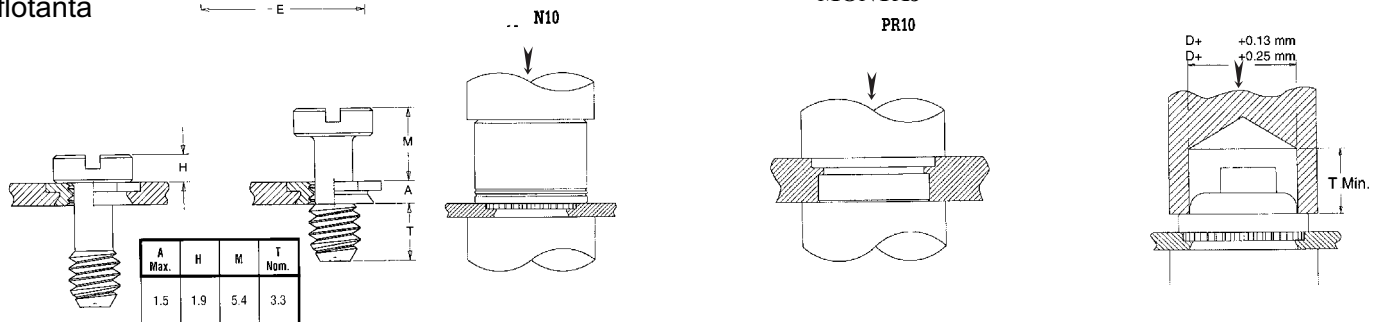

Tip PFT

Surub cu cap de plastic negru
(Alte culori la cerere)

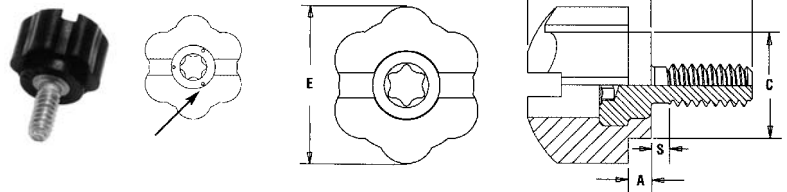

filet	Tip	Cod filet	Cod inel	A ± 0.25	C ± 0.40	E ± 0.40	G ± 0.64	S Max.	T ± 0.40			
M3 x 0.5	PFT	L	M3	0	1.91	8.89	12.7	8.5	1.05	10.34	#10	3.73
				1				12.7				
M3.5 x 0.6	PFT	L	M3.5	0	1.91	8.89	12.7	8.5	1.25	10.34	#15	3.96
				1				12.7				
M4 x 0.7	PFT	L	M4	0	1.91	10.16	14.73	8.5	1.45	11.71	#20	4.78
				1				12.7				
M5 x 0.8	PFT	L	M5	0	1.91	10.16	14.73	8.5	1.65	11.71	#20	5.28
				1				12.7				